



DATA SHEET



TOUCH SCREEN

Si-C320

Multifunction transmitter

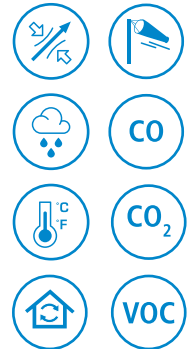

Multifunction for VAC and IAQ applications

4 x analogue outputs

2 x inputs for external probes

1 x RS-485 interface for Modbus RTU protocol



Sauermann Control



FEATURES

- Graphic touch display
- Visual channel alarms + acoustic alarm
- Wireless communication (optional) with mobile app
- IP 66, VHP* resistant

For clean rooms, regulated environments and industrial VAC applications where an efficient regulation/monitoring of the air parameters is needed, our Si-C320 transmitters provide reliable measurements and allow achieving compliance with the strictest regulations.

Several models are available, it is possible to create your multifunction transmitter according to your needs on the last page of this data sheet.

Common features of these multifunction transmitters:

- 4 x configurable analogue outputs (4-20 mA/0-20 mA or 0-10 V / 0-5 V)
- 1 x RS-485 interface for Modbus RTU protocol communication
- 2 x inputs for external interchangeable probes
- 1 x slot for optional differential pressure module
- 1 x slot for optional relay module
- 1 x slot for optional wireless communication module
- Data recording with the possibility of downloading them via Sauermann Control software/app
- Possibility to edit the channel names
- IP66 plastic enclosure, resistant to VHP*
- Power supply 24 V_{AC} / 24 V_{DC}

EXAMPLES OF APPLICATION



Monitoring and regulation of differential pressure, relative humidity, temperature, air velocity and ACR** in cleanrooms and operating rooms



Dynamic pressure/ psychrometry/ temperature/airflow/ACR** regulation in air handling units and ductworks



Laminar flow monitoring (clean rooms, glove boxes, fume hoods, isolation cabinets, liquid filling machines)









Monitoring of drying processes in industrial manufacturing (bricks, pasta...)

*Vaporized hydrogen peroxide
**Air Change Rate



Google Play and the Google Play logo are trademarks of Google LLC.
App Store is a service mark of Apple Inc.

POSSIBLE OPTIONAL MEASUREMENTS

The following **probes and modules** are available as an option for Si-C320 transmitters. For further details please see the probes technical data sheet for class 320 transmitters.

Probes / modules	Measuring ranges	Calculated parameters
 Differential pressure module (with terminal block for K thermocouple probe)	Available ranges from -50/50 Pa to -10 000/10 000 Pa (-0.2/0.2 inH ₂ O to -40 to 40 inH ₂ O) (according to the module) -200 to 1300°C (-328 to 2372 °F) (depending on the connected probe)	Air velocity: up to 100 m/s (0 to 328 fps) Air flow: 0 to 999,999 m ³ /h (0 to 588,577 cfm) Air change rate: 0 to 1000 ACH
 Relative humidity / temperature probe	0 to 100 %RH and -40 to 150 °C (-40 to 302 °F) (according to the probe)	Dew point: -50 to 100 °C _{td} (-58 to 212 °F _{td}) Wet-bulb temperature: -50 to 100 °C _{tw} (-58 to 212 °F _{tw}) Frost point: -50 to 100 °C _{tf} (-58 to 212 °F _{tf}) Enthalpy: 0 to 15,000 kJ/kg Absolute humidity: 0 to 1000 g/m ³ Mixing Ratio: 0 to 1000 g/kg
 Temperature probe	-80 to 150 °C (-112 to 302 °F)	N/A
 Air velocity / temperature probe	0 to 30 m/s (0 to 98.4 fps) and 0 to 50 °C (32 to 122 °F)	Air flow: 0 to 999,999 m ³ /h (0 to 588,577 cfm) Air change rate: 0 to 1000 ACH
 CO probe	0 to 500 ppm	N/A
 CO₂ probe	0 to 10,000 ppm	N/A
 VOC probe	TVOC: 0 to 1000 ppb CO ₂ eq: 400 to 2000 ppm	N/A

GENERAL FEATURES

Power supply	24 V _{AC} / V _{DC} ±10%
Outputs	Warning: risk of electric shock  4 x 4-20 mA, 0-20 mA, 0-10 V and 0-5 V analogue outputs Common mode voltage <30 V _{AC} Maximum load: 500 Ω (0/4-20 mA) Minimum load: 1 KΩ (0-5/10 V)
Galvanic isolation	Inputs (power supply) and outputs Device fully protected by  DOUBLE ISOLATION or REINFORCED ISOLATION
Consumption with probe and without option	15 VA
Electrical connections	Screw terminal block for cables from 0.05 to 2.5 mm ² or from 30 to 14 AWG Carried out according to the code of good practices
RS-485 communication	Modbus RTU protocol, configurable communication speed from 2400 to 115200
Wireless communication (option)	Range frequency from 2402 MHz to 2480 MHz with a transmission power of 0 dBm. Range up to 15 m (50 ft), depending on smartphone radio strength. Minimum required versions: Android 5.0, iOS 12.4, BLE 4.0
Audible alarm	Buzzer (60 dB at 10 cm)
Environment and type of fluid	Air and neutral gases
Conditions of use (°C/%RH/m)	From -10 to 50 °C (14 to 122 °F) In non-condensing environment From 0 to 2000 m (0 to 6561 feet)
Storage temperature	From -10 to 70 °C (14 to 158 °F)
Security	Protection class 2 - Pollution degree 2 - Overvoltage category 2
European directives	2014/30/EU EMC - 2014/35/EU Low Voltage - 2014/53/EU (RED) - 2015/863 EU (RoHS 3) - 2012/19/EU WEEE

FEATURES OF THE HOUSING

Material	ABS V0 as per UL94
Protection	IP66, resistant to VHP
Display (optional)	Color Touch Screen with graphing Size: 480 x 272 pixels
Cable gland	In polycarbonate for cables from Ø 4.5 to 8 mm (Ø 0.18" to 0.32")
Weight	626 g (1.4 lb)

WALL-MOUNT FIXING PLATE DIMENSIONS

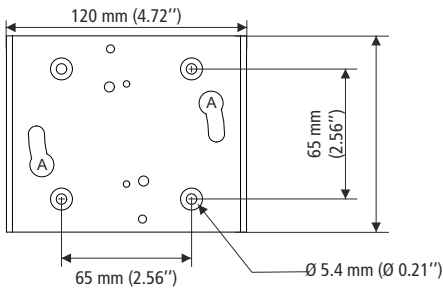

DEVICE DIMENSIONS

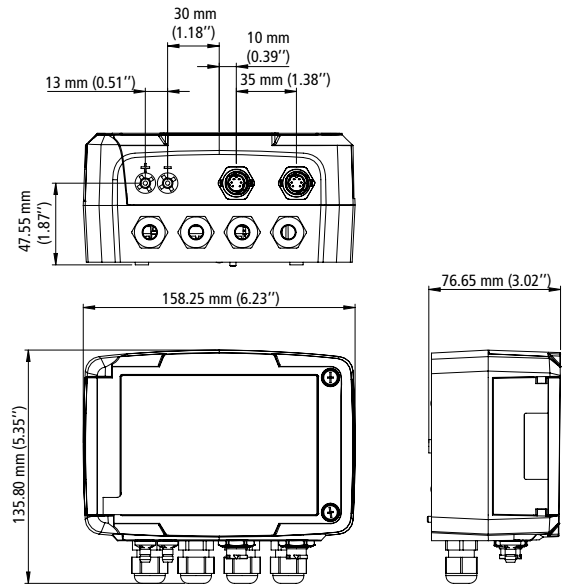

ALARMS

The Si-C320 transmitter has 4 independent and configurable alarms: these are visual and audible alarms.

Available settings:

- Selection of the parameter (pressure, air velocity, temperature,...)
- Time-delays duration from 0 to 600 s
- Alarm action: rising edge, falling edge, monitoring or state of the transmitter
- Activation of the audible alarm (buzzer) that can be acknowledged by touching the screen

MODBUS PROTOCOL

Class 320 transmitters can be linked in one network operating on a RS485 bus.

The RS 485 digital communication is a 2-wire network, on which the transmitters are connected in parallel. They are connected to a PLC/BMS via the Modbus RTU communication system.

CONFIGURATION

Class 320 transmitters allows you to set all the parameters managed by the transmitter: units, measuring ranges, alarms, outputs, channels... via the different methods shown below:

- **Via on-board menu, only on models with display.** A code-locking system guarantees the security of the installation. See the user manual.
- **Via software and app:** simple and user-friendly. See mobile app/software user manual.

OUTPUTS DIAGNOSTICS

With this function, you can check with a multimeter (or on a regulator/display, or on a PLC/BMS) if the transmitter outputs work properly. The transmitter generates a voltage of 0 V, 5 V and 10 V or a current of 0 mA, 4 mA, 12 mA and 20 mA.

ACCESSORIES

Designation	Sales reference	Description
Si-ACC-WLM	28007	Wireless communication module for the configuration of Si-C320 transmitters using the iOS/Android mobile app. For installation in already delivered Si-C320 transmitters.
Si-M4R	27997	4x relay module for Si-C320 transmitters. SPDT relays 40 V _{DC} / 600 mA. For installation in already delivered Si-C320 transmitters.
Si-ACC-USB-CC	27998	USB-mini DIN interface for connecting of the class 320 transmitters to the configuration PC software.
Si-ACC-rail	28003	DIN rail mounting kit for Si-C320 transmitters.
Si-ACC-OS	28005	Protective shield for transmitters. It ensures the protection of transmitters against solar radiation and most of the precipitation when these are installed outdoors.
KI-AL-750-A	24709	Class 2 power supply. DIN rail mounting. Input voltage: 230 V _{AC} . Output voltage: 24 V _{AC} . Nominal power 18 VA, intensity 750 mA.
KI-AL-1000-C	13973	Class 2 stabilized power supply. Mounting with integrated brackets. Input voltage: 230 V _{AC} , output voltage: 24 V _{DC} . Nominal power: 24 VA. Intensity: 1 A.
PF300	13825	Stainless steel wall-mount plate.



Only the accessories supplied with the device must be used.

CERTIFICATION

Certificate: transmitters are supplied with an individual adjusting certificate and can be supplied with a calibration certificate as an option.

DESIGNATION

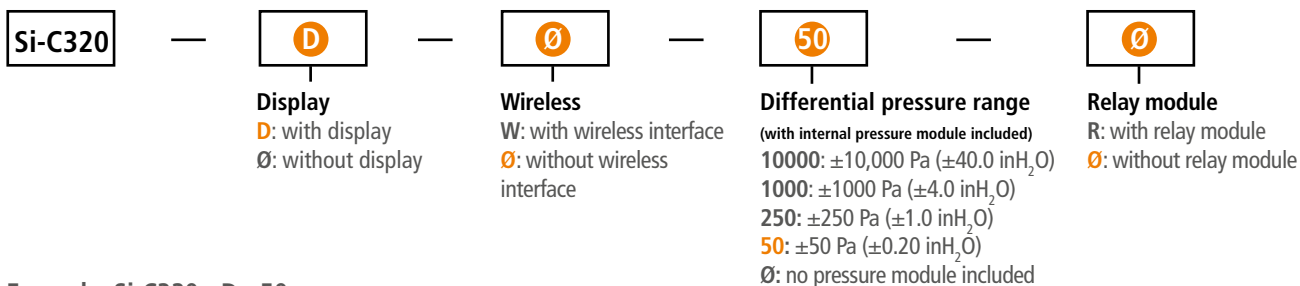

Example: Si-C320 - D - 50

Si-C320 multifunction transmitter with display and differential pressure module (-50 to 50 Pa / -0.20 to 0.20 inH₂O) included.

See below references for our essential transmitters. Other references are available, please visit our website for more information.

Designation	Sales reference	Description
Si-C320-D	27940	Multifunction transmitter with touchscreen. 4 x analogue outputs and 1 x RS485 interface. Inputs for 2 x probes and 1 x differential pressure module. IP66.
Si-C320-D-50	27944	Multifunction transmitter with touchscreen and differential pressure module (-50 to 50 Pa / -0.20 to 0.20 inH ₂ O). 4 x analogue outputs and 1 x RS485 interface. Inputs for 2 x probes. IP66.
Si-C320-D-250	27945	Multifunction transmitter with touchscreen and differential pressure module (-250 to 250 Pa / -1.0 to 1.0 inH ₂ O). 4 x analogue outputs and 1 x RS485 interface. Inputs for 2 x probes. IP66.
Si-C320-D-1000	27946	Multifunction transmitter with touchscreen and differential pressure module (-1000 to 1000 Pa / -4.0 to 4.0 inH ₂ O). 4 x analogue outputs and 1 x RS485 interface. Inputs for 2 x probes. IP66.
Si-C320-D-10000	27947	Multifunction transmitter with touchscreen and differential pressure module (-10,000 to 10,000 Pa / -40.0 to 40.0 inH ₂ O). 4 x analogue outputs and 1 x RS485 interface. Inputs for 2 x probes. IP66.

KIT CONTENT

- Terminal blocks for power connection
- Terminal blocks for output connections
- Wall-mount fixing plate

More information about this product

